

Accessories Catalogue



Accessories
BUSINESS SOLUTIONS





A world of ideas, solutions and proposals dedicated to your New Holland machine. Their purpose is to improve the aesthetics, protection and comfort of your working environment. Thanks to New Holland accessories, you can personalise your machine, adapting it to your needs and enriching it by adding superior equipment.

New Holland accessories offer an unlimited choice of products and instruments. This level of quality can only be found in genuine New Holland parts. Our goal is simple: improving your working environment with new features.

NEW HOLLAND GENUINE ACCESSORIES

Issued 2021

CONTENT

| | |
|-------------------------------------------------------------|-------|
| TRACTOR OVERVIEW _____ | 4-5 |
| CAB COMFORT _____ | 6-17 |
| Driver's Seats / Passenger Seats / Seat Covers / Floor mats | |
| ALL CLEAN _____ | 18-21 |
| Wipers | |
| LIGHTING _____ | 22-27 |
| Working lights / Beacon lights | |
| CAB FILTER _____ | 28-33 |
| Carbon / Pollen Filters | |
| ALLROUND VIEW _____ | 34-37 |
| Mirrors | |
| CAB EQUIPMENT _____ | 38-47 |
| Radios / Steering wheels / Safety-reversing alarms | |
| PRECISION FARMING _____ | 48-51 |
| PLM | |
| FRONT AND REAR EQUIPMENT _____ | 52-59 |
| Drawbar / Trailer hitch / Fender extensions | |
| HARVESTING OVERVIEW _____ | 60-61 |
| HARVESTING ACCESSOIRES _____ | 62-71 |
| CR and CX Combines / Forage Harvester / Large Square Balers | |

All pictures shown in this catalogue are for illustration purpose only.
Actual product may vary due to product enhancement, specification and machine application.

NEW HOLLAND

OVERVIEW

TRACTORS

To be successful in your farming business you need your machines to be powerful, easy to use and capable of performing at their best in the toughest conditions. You need technologies that cut your fuel consumption and operating costs. You need to work fast and efficiently. New Holland helps you meet these demands with innovative technologies created from listening to what customers need. We also know that stock product to fit your expectations need to be enriched with additional equipment. Below you can find machines and accessories for your comfort and better efficiency.

The allocation of part numbers to models in this catalogue is intended to be a guideline. Your dealer will check the actual compatibility with your machine based on a serial number.

T5 AC



AC - STAGE V

T5.110
T5.120
T5.130
T5.140

T5 EC



EC - TIER 4B

T5.100
T5.110
T5.120

T6



EC - TIER 4B - MY18

T6.125
T6.145
T6.155
T6.165
T6.175
T6.180

DC - TIER 4B

T6.145
T6.155
T6.165
T6.175
T6.180

AC - TIER 4B - MY18

T6.145
T6.155
T6.165
T6.175
T6.180

T7 SWB



AC - TIER 4B - MY18

T7.175
T7.190
T7.210
T7.225

CLASSIC - TIER 4B - MY18

T7.165
T7.175
T7.190
T7.195S
T7.210
T7.215S

SIDEWINDER II - TIER 4B - MY18

T7.175
T7.190
T7.210
T7.230

T7 LWB



AC – STAGE V

T7.230
T7.245
T7.260
T7.270

CLASSIC – STAGE V

T7.195S
T7.215S
T7.230
T7.245
T7.260

SIDEWINDER II – STAGE V

T7.230
T7.245
T7.260

T7 HD



AC – STAGE V

T7.290
T7.315

T8 GENESIS



GENESIS – STAGE V

T8.350
T8.380
T8.410
T8.435

T9



Stage 4B

T9.390
T9.450
T9.505
T9.560
T9.615
T9.670

Accessories shown in this catalogue are only proposals for selected models. Please refer to nearest dealer for exact selection for your machine.



01

The image shows the interior of a vehicle cab, likely a tractor or heavy-duty truck. Two seats with grey leather-like upholstery and black armrests are visible. The seats are positioned on a grey perforated floor mat. To the right, there are black control levers and a gear shift. A blue panel is visible at the bottom right. The text "CAB COMFORT" is overlaid in white, bold, sans-serif font. A yellow vertical bar is on the left side of the image.

CAB COMFORT



Given the long hours you spend in your cab, making sure you are more comfortable is one of our main priorities. This is why we have created adaptable seats with enhanced back support that reduce vibrations by up to 40%. You can boost your productivity, comfort and safety, thanks to genuine seats dedicated to your machine. Upgrade your machine for your comfort and safety.



color is different

47940061

Deluxe fabric/leather

Heating/Climatization system
For GARU tractor
Air suspension



47940099

Deluxe fabric/leather

Heating system
For GARU tractor
Air suspension



Pictures shown here are for illustration purpose only.
Please see your local dealer for model applicability
and correct PN for your machine.



**Comfort for the operator
(Vibration Reduction
System seats)**

Reduce vibrations by up to 40% with added back support and numerous customizable settings.



**Carefully designed for hours
of use on the field.**

Long hours spent in your machine require a special design to keep you in good health.



**Remember to check
your seat!**

The seat is one of the machine elements used every time you use your machine. After many hours of usage, you should check your current seat and replace if needed to avoid any physical or health problems.

NEW HOLLAND SEATS RANGE



47940097

Deluxe fabric

For GARU tractor
Air suspension



47940093

Deluxe fabric/leather

Heating/Climatization system
For GARU tractor
Air suspension



Pictures shown here are for illustration purpose only.
Please see your local dealer for model applicability
and correct PN for your machine.



47940038
deluxe fabric

For MTA tractor
Air suspension



47940252
deluxe fabric/leather

Heating seat
For MTA tractor
Air suspension



47940250
deluxe fabric

For MTA tractor
Air suspension



47940041
deluxe fabric

For GARU tractor
Air suspension



Pictures shown here are for illustration purpose only.
Please see your local dealer for model applicability
and correct PN for your machine.



color is different

48015958

deluxe fabric/leather

Seat heating
For MTA tractor
Air suspension



color is different

48015942

deluxe fabric/leather

Seat heating
For GARU tractor
Air suspension



47940098

deluxe fabric

For GARU tractor
Air suspension



47940043

deluxe fabric

For GARU tractor
Air suspension



47934814

standard/fabric

Mechanical suspension



47946277

deluxe fabric

Air suspension
Same as PN 47946272 but armrest A60/380



47946272

deluxe fabric

Air suspension
Same as PN 47946277 but armrest A60/320



example photo: actual color is darker

47946264

standard/fabric

Air suspension



48157412

deluxe fabric

For GARU tractors
Air suspension



Pictures shown here are for illustration purpose only.
Please see your local dealer for model applicability
and correct PN for your machine.



Pictures shown here are for illustration purpose only.
Please see your local dealer for model applicability
and correct PN for your machine.



Comfort

Instructor seats designed to provide the best comfort to your passengers.



Security

Respect all the rules for security on the road and include seat belts.



Quality

Guarantee of Genuine parts.

NEW HOLLAND PASSENGER SEAT

Is important to ensure the security of your passengers, with our instructor seats, be sure that all parameters and rules are respected. They are designed to offer the best comfort and do not take too much space inside the cab.



47940272

grey leather

Seat cover SIMILEO 73329427
Seat cover AIRCO 73326788



47564636

blue fabric

Seat cover SIMILEO 47956353
Seat cover AIRCO 47956352



Pictures shown here are for illustration purpose only. Please see your local dealer for model applicability and correct PN for your machine.



To further enhance your comfort, check out our 2 ranges of covers designed to fit your cab perfectly: AIRCO RANGE and SIMILEO RANGE.



AIRCO



SIMILEO

Pictures shown here are for illustration purpose only.
Please see your local dealer for model applicability
and correct PN for your machine.



Operator comfort

A pleasant work environment will boost your comfort and please your eyes during hours spent in the machine. Learn about our range of different seat covers for each of your needs.



Low maintenance

Easy to clean, the seat covers can be machine washed at 30° but please do not tumble dry. The Simileo imitation leather range can simply be wiped down while in the cab.



Quality

Handmade products, produced in France and Europe.

NEW HOLLAND SEAT COVERS

| SIMILEO | AIRCO |
|----------|----------|
| 73329432 | 73326784 |



47940038



47940041



47940043

| SIMILEO | AIRCO |
|----------|----------|
| 47956351 | 47956350 |



47940098



47940099



47940252



48015958



47940097



48015942



47940250

| SIMILEO | AIRCO |
|----------|----------|
| 73329430 | 73325790 |



47946277



47946272



48157412

Pictures shown here are for illustration purpose only. Please see your local dealer for model applicability and correct PN for your machine.



Made to resist to aggressive environments

All genuine carpets are resistant to UV, mildew and low temps. They are reinforced where needed - where you step to get in the cab. For the dirtiest environments, rubber floor mats are the perfect option.



Reliable

Strict quality controls before packaging of each product ensure that you receive best quality New Holland Accessories. All the products are tailor made and fit perfectly to each cab.

Pictures shown here are for illustration purpose only.
Please see your local dealer for model applicability
and correct PN for your machine.

New Holland floor mats are especially designed for your machine. They protect your floor from dirt, moisture and water while ensuring greater comfort for you during hours spent in the field. All carpets are made with best quality materials to facilitate cab maintenance and cleaning while resale value is maintained.

NEW HOLLAND FLOOR MAT



73329316

carpet



73329317

carpet



73329312

rubber



73329313

rubber

Pictures shown here are for illustration purpose only. Please see your local dealer for model applicability and correct PN for your machine.

ALL CLEAN





02



For optimum safety and comfort, wiper efficiency is essential. The wipers must perfectly clear the entire surface of the windscreen, withstand extreme temperatures (from -30 to +80° C) and the mechanical constraints of the wind and the weight of snow. They must offer a clear field of vision in all situations.

FRONT/REAR WIPER



73329278

450 mm

| | | |
|----------------------------------------------------------------------------------------------|----------------------------------------------------------------------------------------------------|---------------------------------------------------------------------------------------------|
| T5 AC  | T5 EC  | T6  |
| T7 SWB  | T7 LWB  | T7 HD  |

Pictures shown here are for illustration purpose only.
Please see your local dealer for model applicability
and correct PN for your machine.



New Holland wipers are made entirely from metal fitted with a flexible rubber blade
Our blades are tested under extreme conditions to guarantee extended service life, work comfort, visibility and high quality wiping during the entire lifespan of the product.



Clear view in all conditions
The metal frame ensures constant pressure on the area to be cleaned (+1000 pressure points), providing perfect visibility and silent wiping in extreme weather conditions.



When should the windscreen wipers be replaced?
Weather elements such as heat, frost and UV rays, together with dirt and dust, cause wear to the wipers which can cause damage to the glass elements. To guarantee optimum safety and visibility, New Holland recommends replacing the wipers at first sign of rubber damage.

NEW HOLLAND WIPERS

FRONT WIPER



73329276

550 mm



REAR WIPER



73329275

500 mm



Pictures shown here are for illustration purpose only.
Please see your local dealer for model applicability
and correct PN for your machine.

LIGHTING





03



| | | | | |
|--------------------------|------------------------|---------------|--------------------|------------------------|
| LED 5.000°K - 6.000°K | Mid-day Sun 5.500°K | HD 4.000°K | Halogen 3.000°K | Candlelight 1.000°K |
|--------------------------|------------------------|---------------|--------------------|------------------------|

FRONT / REAR



example photo

47608140

Led

| | | |
|--------------------------------------------------------------------------------------------|--------------------------------------------------------------------------------------------|-------------------------------------------------------------------------------------------|
| T5 AC  | T5 EC  | T6  |
| T7 SWB  | T7 LWB  | T7 HD  |



47608966

Led

| | | |
|----------------------------------------------------------------------------------------------|----------------------------------------------------------------------------------------------|---------------------------------------------------------------------------------------------|
| T5 AC  | T5 EC  | T6  |
| T7 SWB  | T7 LWB  | T7 HD  |

Pictures shown here are for illustration purpose only.
Please see your local dealer for model applicability
and correct PN for your machine.

Colour temperature is a characteristic of visible light. Like temperature, it is measured in Kelvin (°K). The human eye functions more effectively when viewing objects illuminated by a light source with a colour temperature close to that of natural daylight. **A work light with a higher colour temperature will help prevent machine operator fatigue, meaning a safer and more productive work environment.**



Reduced power consumption
reduces consumption by 50% compared to Halogen.



Long life span
LED lighting is designed to last the life of the machine (no upkeep costs)



Higher color temperature:
less eye fatigue.



Vibration dampened
to survive harsher working environments.

NEW HOLLAND WORKING LIGHTS

FRONT



47608966

Led



REAR



example photo

47608140

Led



Pictures shown here are for illustration purpose only.
Please see your local dealer for model applicability
and correct PN for your machine.



HALOGEN BEACONS

A FACTORY-ORIGINAL REPLACEMENT



84337818

Flexible



87723255

Fixed Socket



Pictures shown here are for illustration purpose only.
Please see your local dealer for model applicability
and correct PN for your machine.



Optimum protection against dust and humidity

The high protection rating (IP65) of New Holland flashing beacons offers excellent weatherproofing against external elements including dust and water.



Light intensity: + 30 %

The New Holland flashing beacon consists of an LED group which ensures optimum distribution of the light beam and high visibility. Tests show that New Holland beacons give out 30 % more light than required by European standards.



Shock resistance, unbreakable domes

The polycarbonate dome means the New Holland beacon dome is virtually unbreakable. Unbranded replacement domes, often made out of polymethacrylate, break frequently and are not very durable.

NEW HOLLAND BEACONS

LED BEACONS

AN UPGRADED LED BEACON REPLACEMENT



73331732

Flexible



73331729

Fixed Socket



Pictures shown here are for illustration purpose only. Please see your local dealer for model applicability and correct PN for your machine.

04

CAB FILTERS

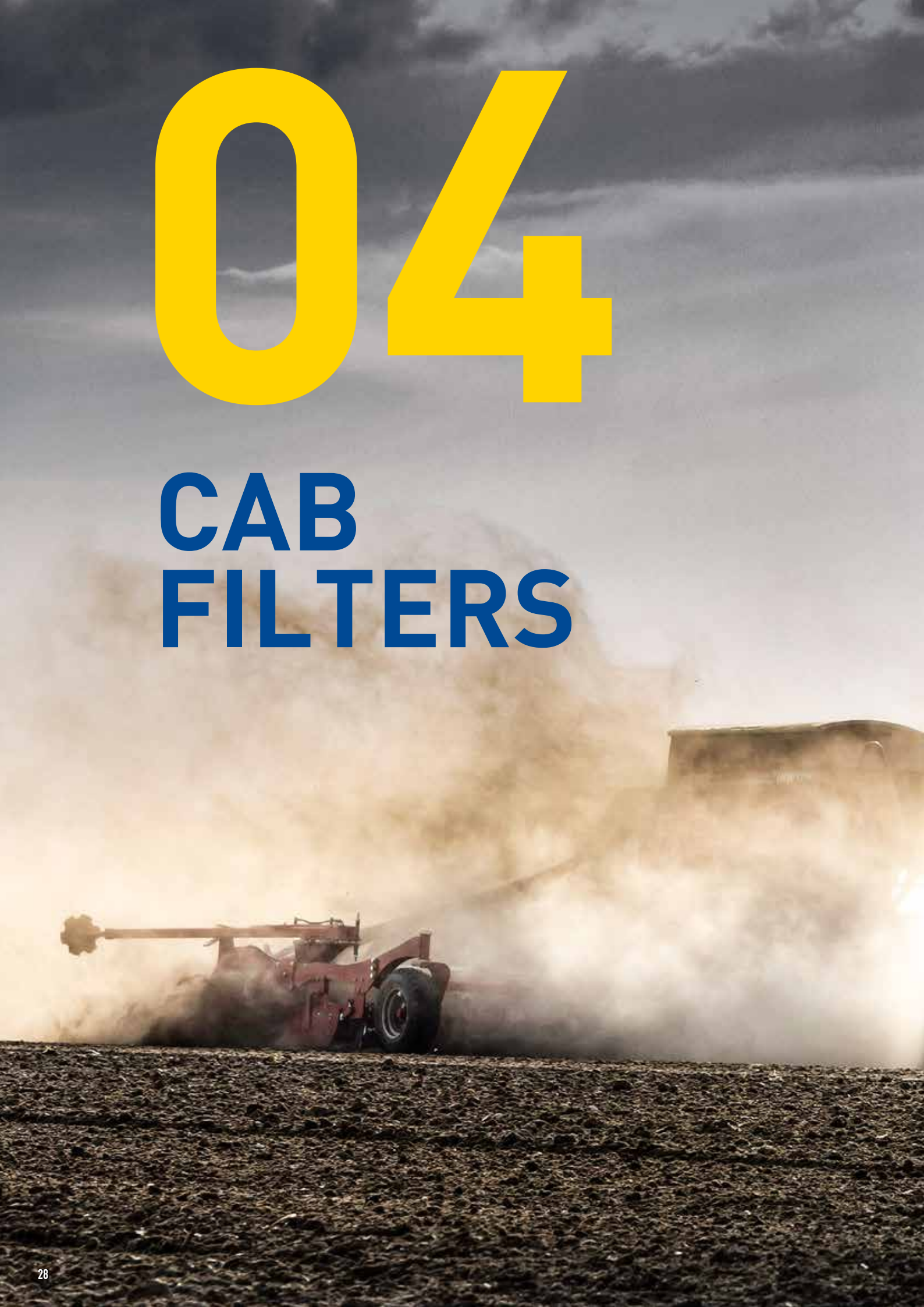





High production quality

The pollen cab air filter features a good linear joint thanks to solid metal frame, providing optimal density of the layers to keep most of particles inside.



Smooth flow of best quality air

Thanks to proper construction and density of the Media, genuine cab air filters RETAIN dangerous particles & improve the flow of good quality air to the operator.



High capacity

The cab air filter must be able to store all the particles which accumulate until the next maintenance service.

The particles accumulated fall into 4 categories:

- Pollution
- Dust
- Bacteria
- Harmful particles, herbicides and fertilizers

NEW HOLLAND POLLEN FILTERS

We know that your professional activities mean you have to work outside on a daily basis, in changing weather conditions and with harmful particles. Only an original cabin filter will effectively protect the operator. This filter must be changed very regularly to maintain its optimal filtration properties. Air circulating in the cabin is purified of all the toxic particles. This device allows the quality of the air circulating in the cab to be controlled, and as such, is a key element in protecting the operator.

Pictures shown here are for illustration purpose only.
Please see your local dealer for model applicability
and correct PN for your machine.



example photo

POLLEN FILTERS



87726675



also available for TSA & T6000



84579424



also available for T4



47565055



Pictures shown here are for illustration purpose only.
Please see your local dealer for model applicability
and correct PN for your machine.



THERE ARE 2 TYPES OF CARBON CAB AIR FILTERS:

- Activated carbon impregnated filter
- Granulated activated carbon filter



ACTIVATED CARBON IMPREGNATED FILTER

In addition to preventing dust and pollen from penetrating the cab of the tractor, this filter also filters out bad odors.



GRANULATED ACTIVATED CARBON FILTER

This filter traps dust, bad odors and most kinds of pollutions. Thanks to an additional layer of Activated Carbon, it ensures an extended Operator safety and comfort.

NEW HOLLAND CARBON FILTERS

Carbon air filters thanks to construction and filtering material gives you guarantee of the protection against aggressive combination of the particles. The cabin air with carbon ensures cleanest air for the operator from all accessible options.

Pictures shown here are for illustration purpose only.
Please see your local dealer for model applicability
and correct PN for your machine.



CARBON FILTERS



87309516



also available for TS, T6000, T7000, T7500



47425992

HP



also available for T5000



47129095



also available for TNFA, TNNA, TNSA, TNVA, T4000

Pictures shown here are for illustration purpose only.
Please see your local dealer for model applicability
and correct PN for your machine.

The image shows the interior of a combine harvester cab. The view is from the driver's perspective, looking out over a vast, golden-brown field of harvested grain. The cab's interior features two seats, a steering wheel with a logo, and various control panels. A large yellow warning sign is visible on the left side of the cab. The text "ALLROUND VIEW" is overlaid in large, bold, yellow letters across the center of the image.

**ALLROUND
VIEW**

05





The quality of New Holland

All of the Accessories are top quality to maintain and increase value of your machine.



Additional and accessory mirrors

Increase the visibility and security of the sides and to the rear of the machine during your work and transportation.

Wide angle mirrors offer a perfect view, and 360° visibility is a key safety feature for operators and their surroundings. You can add any compatible mirror to control your attachments without turning around to look behind you.

NEW HOLLAND MIRRORS

Pictures shown here are for illustration purpose only.
Please see your local dealer for model applicability
and correct PN for your machine.



710960024

Mirror installed on rear window grabrail to optimize view of the pick-up hitch.



719876014

Wide Angle Mirror
(to replace standard mirror inside cab),
for a view of the center rear of the tractor.



718794034

Telescopic arms (x2)
and rear view mirrors (x2)
To replace standard arms.
Ideal for road transport as they allow the
operator to see behind a 3 meter wide trailed
or mounted implement.



718210020

Rear view mirror.
Kit with left & right rear wide angle mirrors,
for road transport. This improves the rear
visibility while driving and can be retracted
in width to fit narrow drive ways.
This is for T5 EC TMR models only.



718837070

Telescopic rear view mirrors.
Kit with left & right rear mirrors,
for road transport. Can be retracted
in width to fit narrow drive ways.
This is for T5 EC non-TMR models only.



718210010

2 rear wide mirrors.
To improve rear visibility while driving.
Can be retracted in width to fit narrow
drive ways.



Pictures shown here are for illustration purpose only.
Please see your local dealer for model applicability
and correct PN for your machine.



CAB EQUIPMENT

06





STORAGE BOX

It provides a tidy storage space and it can be easily removed.
Not suitable for machines fitted with navigation control.

718577054

DIA kit REAR CAB STORAGE BOX

T5 AC



T5 EC



T6



T7 SWB



T7 LWB



T7 HD



Pictures shown here are for illustration purpose only.
Please see your local dealer for model applicability
and correct PN for your machine.



Security
The coolbox and storage box will not move during your field work.



Quality
Genuine products, guarantee of quality.



Fit perfectly:
It is designed to fit with your cab and installation is very easy thanks to the instruction sheet provides with the kit.

NEW HOLLAND STORAGE BOX & COOLBOX

COOLBOX

Stay refreshed on the hottest days.

The optional portable coolbox mounted to the right of the operator seat can be easily removed for replenishment. Keep your food and drinks cool during your hard work.

48062995

DIA kit Coolbox with bracket

T8 STAGE V 

47789890

DIA kit Coolbox with bracket

T8 T4B 



non contractual picture

Pictures shown here are for illustration purpose only. Please see your local dealer for model applicability and correct PN for your machine.

Our new models have excellent dust protection thanks to hidden ports for USB devices and SD memory cards. Oversized buttons make it easy to use in the field, and the latest software for Bluetooth add connectivity options to pair your personal devices. Get a clear, uninterrupted signal thanks to the improved antenna connection and vibration resistant circuits built in radio.



Suitable

Our radio are made to resist to dirty environments and dust.



Technology

The best technology with integrated bluetooth.



High capacity

Guarantee of Genuine parts.

NEW HOLLAND RADIO



73330924

New radio – BLUETOOTH

T5 AC



T5 EC



T6



T7 SWB



T7 LWB



T7 HD



Pictures shown here are for illustration purpose only. Please see your local dealer for model applicability and correct PN for your machine.



Pictures shown here are for illustration purpose only.
Please see your local dealer for model applicability
and correct PN for your machine.

The steering wheel will, by necessity, experience wear during the service life of your machine. Replace it with a genuine part to keep your machine in good shape and maintain its value.



Best fit of Genuine Parts and accessories

Your steering wheel will fit as well as it did from the factory.



Resistant Materials

You can feel the top quality materials used for production



Safety

Restrictions and top quality production processes ensure safety for the operator.

NEW HOLLAND STEERING WHEELS

84574824

Standard



84593292

Leather/Deluxe



5091213

Standard



Pictures shown here are for illustration purpose only. Please see your local dealer for model applicability and correct PN for your machine.



Pictures shown here are for illustration purpose only.
Please see your local dealer for model applicability
and correct PN for your machine.



REVERSING ALARMS

Triggers a sonal alarm or light when a reverse gear is engaged - alerts by-standers that the vehicle is moving rearwards.



example photo

84470196

Alarm, Audible reversing

| | | |
|--------------------------------------------------------------------------------------------|--------------------------------------------------------------------------------------------|-------------------------------------------------------------------------------------------|
| T5 AC  | T5 EC  | T6  |
| T7 SWB  | T7 LWB  | T7 HD  |

718106084

Alarm, Audible reversing

| | | |
|----------------------------------------------------------------------------------------------|----------------------------------------------------------------------------------------------|---------------------------------------------------------------------------------------------|
| T5 AC  | T5 EC  | T6  |
| T7 SWB  | T7 LWB  | T7 HD  |

719443044

Alarm + light

| | | |
|--------------------------------------------------------------------------------------------|--------------------------------------------------------------------------------------------|-------------------------------------------------------------------------------------------|
| T5 AC  | T5 EC  | T6  |
| T7 SWB  | T7 LWB  | T7 HD  |

719161034

Alarm + light

| | | |
|--------------------------------------------------------------------------------------------|--------------------------------------------------------------------------------------------|-------------------------------------------------------------------------------------------|
| T5 AC  | T5 EC  | T6  |
| T7 SWB  | T7 LWB  | T7 HD  |

718825070

Alarm + light

| | | |
|----------------------------------------------------------------------------------------------|----------------------------------------------------------------------------------------------|---------------------------------------------------------------------------------------------|
| T5 AC  | T5 EC  | T6  |
| T7 SWB  | T7 LWB  | T7 HD  |

Pictures shown here are for illustration purpose only. Please see your local dealer for model applicability and correct PN for your machine.



Easy to use accessory
Only 2,5 hours to install it on your machine.



Exceptional reliability
Best in class features like loudness of reversing alarm (107dB(A)) or +/- 15m visibility in night mode for camera for safe and convenient use.



Security
Increase the security of your daily work and protect the others.



Vibration dampened
Epoxy sealed and reinforced housing to survive harsher working environments like dust, moisture or high pressure washing.

NEW HOLLAND

SAFETY

REVERSING CAMERA 120°

A reversing camera helps you to see what is behind your machine. Offered cameras are resistant, waterproof and dustproof. Backlight control function and infrared night vision, provide better visibility.



73328098 (CAMERA)
73329170 (CABLE)

Camera + 20 m extension cable

T5 AC



T5 EC



T6



T7 SWB



T7 LWB



T7 HD



Pictures shown here are for illustration purpose only.
Please see your local dealer for model applicability
and correct PN for your machine.



PRECISION LAND MANAGEMENT



07



INTELLI
STEER

INTELLISTEER - INTEGRATED STEERING

IntelliSteer is a fully integrated New Holland designed and developed Automatic Steering System. It is the ultimate guidance solution which offers complete machine direction control at the touch of a button. Uses a single integrated display with the IntelliView™ IV for machine functions, auto guidance, mapping and implement control.

The T3™ Terrain Compensation system uses sensors to calculate and correct the roll, pitch and yaw of the machine to help minimize skips and overlaps in areas with rolling terrain and rough ground.

NEW HOLLAND

PLM

Pictures shown here are for illustration purpose only.
Please see your local dealer for model applicability
and correct PN for your machine.



New Holland offers a full range of guidance solutions that can be tailored to suit your individual needs. With a full range of correction signals, New Holland's modular solution can be used on any machine. Intuitive, user-friendly interfaces mean you can use guidance with confidence. PLM® software analyses and plans your in-field tasks so you can enjoy the benefits of more efficient farming. You'll be reducing inputs, saving money, as well as benefiting the environment. Reduced inputs mean reduced energy-intensive manufacturing and also less wastage and run off. More efficient coverage of your land boosts your profits and gives Mother Nature a helping hand.

PLM

NEW HOLLAND INTELLIGENCE



ZTN156361-60

PLM Completion package
(includes the PLM 372 antenna,
Egnos and the Nav. controller III)



51479019

IntelliView IV Display



ZTN11240760SP

Bundle including RV55 Modem,
AFS 372 Modem Cable,
Passcode AFS 372 Upgrade to RTK



Pictures shown here are for illustration purpose only.
Please see your local dealer for model applicability
and correct PN for your machine.



FRONT AND REAR EQUIPMENT

08



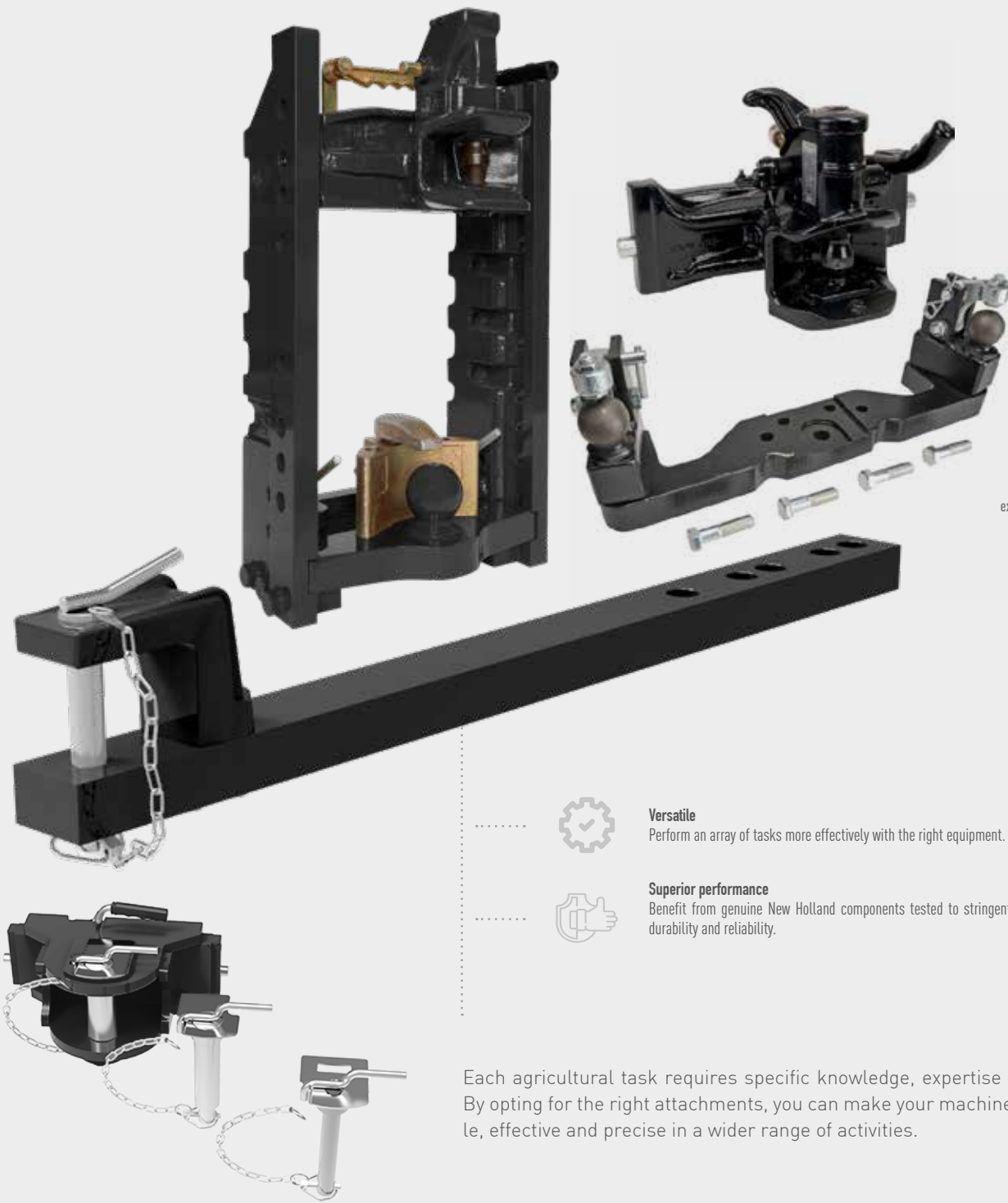

example photo



Versatile

Perform an array of tasks more effectively with the right equipment.



Superior performance







































































































Benefit from genuine New Holland components tested to stringent standards for maximum durability and reliability.

Each agricultural task requires specific knowledge, expertise and equipment. By opting for the right attachments, you can make your machines more versatile, effective and precise in a wider range of activities.

NEW HOLLAND TRAILER HITCH & DRAWBAR

Pictures shown here are for illustration purpose only. Please see your local dealer for model applicability and correct PN for your machine.

DRAW BARS

| | | | |
|-----------------------------------------------------------------------------------------------------------------------------------------------------------------------------------------------------------------------------------------------------------------------------------------------------------------------------------------------------------------------------------------------------------------------------------------------------------------------------------------------------------------------------------------------------------------------------------------------------------------------------|------------------------------------------------------------------------------------------------------------------------------------------------------------------------------------------------------------------------------------------------------------------------------------------------------------------------------------------------------------------------------------------------------------------------------------------------------------------------------------------------------------------------------------------------------------------------------------------------------------------------|----------------------------------------------------------------------------------------------------------------------------------------------------------------------------------------------------------------------------------------------------------------------------------------------------------------------------------------------------------------------------------------------------------------------------------------------------------------------------------------------------------------------------------------------------------------------------------------------------------------------------|----------------------------------------------------------------------------------------------------------------------------------------------------------------------------------------------------------------------------------------------------------------------------------------------------------------------------------------------------------------------------------------------------------------------------------------------------------------------------------------------------------------------------------------------------------------------------------------------------------------------------------------------|
| <p>47961032</p> <p>Assembly Drawbar for hydraulic pick up</p> <p>T5 AC  T5 EC  T6 </p> <p>T7 SWB  T7 LWB  T7 HD </p> | <p>47983353</p> <p>Assembly Drawbar K80 APUH</p> <p>T5 AC  T5 EC  T6 </p> <p>T7 SWB  T7 LWB  T7 HD </p> | <p>47968780</p> <p>Assembly drawbar cat 2 above 130KW</p> <p>T5 AC  T5 EC  T6 </p> <p>T7 SWB  T7 LWB  T7 HD </p> | <p>47968781</p> <p>Assembly drawbar cuna above 130KW</p> <p>T5 AC  T5 EC  T6 </p> <p>T7 SWB  T7 LWB  T7 HD </p> |
| <p>82027758</p> <p>Assembly drawbar swinging</p> <p>T5 AC  T5 EC  T6 </p> <p>T7 SWB  T7 LWB  T7 HD </p> | <p>87566051</p> <p>Drawbar swinging Naso</p> <p>T5 AC  T5 EC  T6 </p> <p>T7 SWB  T7 LWB  T7 HD </p> | <p>87566048</p> <p>Drawbar swinging EEC</p> <p>T5 AC  T5 EC  T6 </p> <p>T7 SWB  T7 LWB  T7 HD </p> | <p>87566049</p> <p>Assembly drawbar swinging EEC</p> <p>T5 AC  T5 EC  T6 </p> <p>T7 SWB  T7 LWB  T7 HD </p> |
| <p>47942375</p> <p>Drawbar CEE with clevis</p> <p>T5 AC  T5 EC  T6 </p> <p>T7 SWB  T7 LWB  T7 HD </p> | <p>47981683</p> <p>Drawbar cat 2</p> <p>T5 AC  T5 EC  T6 </p> <p>T7 SWB  T7 LWB  T7 HD </p> | <p>84229800</p> <p>Assembly drawbar cat 3</p> <p>T5 AC  T5 EC  T6 </p> <p>T7 SWB  T7 LWB  T7 HD </p> | <p>47968778</p> <p>Assembly drawbar cuna</p> <p>T5 AC  T5 EC  T6 </p> <p>T7 SWB  T7 LWB  T7 HD </p> |
| <p>47972855</p> <p>Assembly Drawbar APUH cat 2</p> <p>T5 AC  T5 EC  T6 </p> <p>T7 SWB  T7 LWB  T7 HD </p> | <p>47968777</p> <p>Assembly drawbar cat 2</p> <p>T5 AC  T5 EC  T6 </p> <p>T7 SWB  T7 LWB  T7 HD </p> | <p>87558072</p> <p>Swinging drawbar Naso</p> <p>T5 AC  T5 EC  T6 </p> <p>T7 SWB  T7 LWB  T7 HD </p> | <p>47983345</p> <p>Assembly drawbar APUH</p> <p>T5 AC  T5 EC  T6 </p> <p>T7 SWB  T7 LWB  T7 HD </p> |
| <p>82027971</p> <p>Assembly drawbar roller</p> <p>T5 AC  T5 EC  T6 </p> <p>T7 SWB  T7 LWB  T7 HD </p> | <p>84129985</p> <p>Drawbar</p> <p>T5 AC  T5 EC  T6 </p> <p>T7 SWB  T7 LWB  T7 HD </p> | <p>5180877</p> <p>Drawbar CEE</p> <p>T5 AC  T5 EC  T6 </p> <p>T7 SWB  T7 LWB  T7 HD </p> | <p>82025930</p> <p>Assembly Drawbar APUH mechanical</p> <p>T5 AC  T5 EC  T6 </p> <p>T7 SWB  T7 LWB  T7 HD </p> |

Pictures shown here are for illustration purpose only. Please see your local dealer for model applicability and correct PN for your machine.

TRAILER HITCH



47983331

Trailer hitch, AUTO 38mm



47983337

Trailer Hitch K80

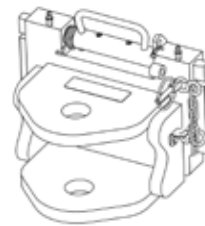

48173954

Trailer hitch coupling Cuna D2

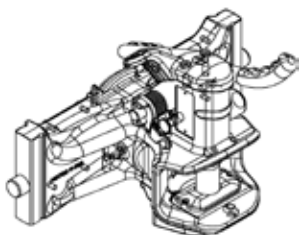

47553620

Trailer hitch Coupling, auto 32mm

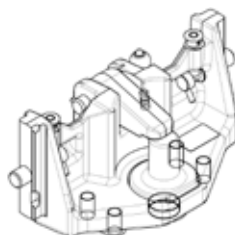

47972830

Trailer Hitch Piton fix

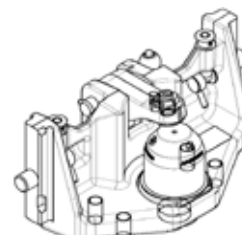

47972832

Sliding trailer hitch K80

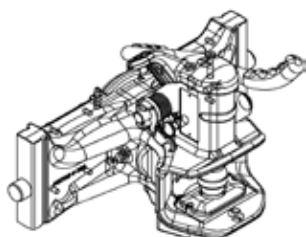

47539955

Trailer hitch Coupling, auto 38mm

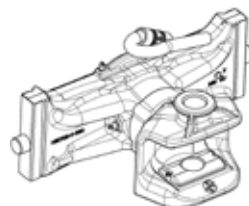

47540256

Trailer hitch coupling manual



48173958

Trailer hitch coupling Cuna C



Pictures shown here are for illustration purpose only. Please see your local dealer for model applicability and correct PN for your machine.

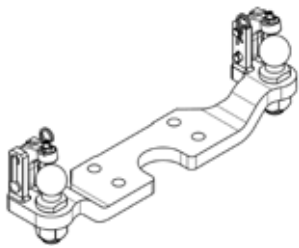

47553609

Steering guidance K80 ball

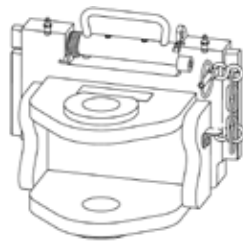

48173956

Trailer hitch D3 CUNA

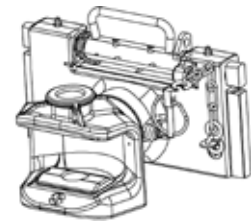

5199447

Swinging trailer hitch

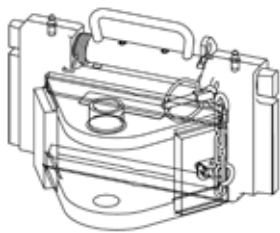

48173952

Trailer hitch coupling Cuna C

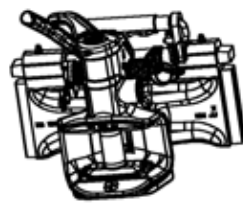

47942360

Sliding trailer hitch automatic

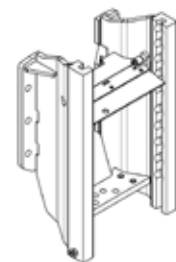

48177687

Hitch support

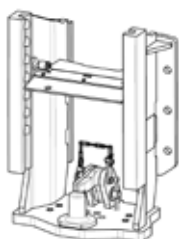

48177689

Hitch support with piton

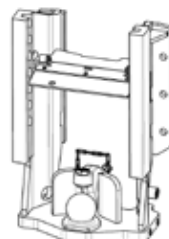

48177690

Hitch support K80

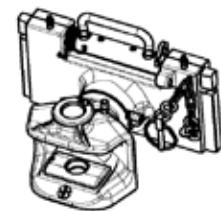

47942361

Swinging trailer hitch



Pictures shown here are for illustration purpose only.
Please see your local dealer for model applicability
and correct PN for your machine.



Safety

Fenders will allow you to ensure your visibility is maintained through adverse weather conditions and inconsistent terrain.



Genuine

They can be installed really quickly at your dealership and they are designed to fit perfectly with your tractor.

The DIA kits fenders are an excellent cab protection from mud splashes and rocks. The option dynamic fenders allows a tighter steering radius, in particular at narrower track settings.

NEW HOLLAND FENDER EXTENSIONS

Pictures shown here are for illustration purpose only.
Please see your local dealer for model applicability
and correct PN for your machine.



710860521

DIA kit.
Fixed front fenders



718487040

DIA kit.
Dynamic front fenders 400 mm



718826070

DIA kit.
Dynamic front fenders 480 mm



718487001

DIA kit.
Dynamic Front Fenders 410 mm



718826001

DIA kit.
Dynamic Front Fenders 480 mm



710869134

DIA kit.
Rear Fender small extensions



718510024

DIA kit.
Dynamic Front Fenders 420 mm



718511024

DIA kit.
Dynamic Front Fenders 480 mm



718775024

DIA kit.
Dynamic Front Fenders 540 mm



718293014

DIA kit.
Rear Fender extension 75 mm



718601014

DIA kit.
Rear Fender extension 150 mm



719167064

DIA kit.
Dynamic Front Fenders 480 mm



718776044

DIA kit.
Dynamic Front Fenders 620 mm



718776064

DIA kit.
Dynamic Front Fenders 620 mm



710869104

DIA kit.
Rear fender extension



710869144

DIA kit.
Rear Fender extension - narrow



718293044

DIA kit.
Rear Fender extension - wide



718776054

DIA kit.
Dynamic Front Fenders 620 mm



731023014

DIA kit.
Dynamic Front Fenders 680 mm



Pictures shown here are for illustration purpose only.
Please see your local dealer for model applicability
and correct PN for your machine.

NEW HOLLAND

OVERVIEW

HARVESTING

To be successful in your farming business you need your machines to be powerful, easy to use and capable of performing at their best in the toughest conditions. You need technologies that cut your fuel consumption and operating costs. You need to work fast and efficiently. New Holland helps you meet these demands with innovative technologies created from listening to what customers need.

We also know that stock product to fit your expectations need to be enriched with additional equipment. Below you can find range of harvesting machines and accessories which can be fitted for your comfort and better efficiency.

CX5–6



STAGE 4B

CX5.80
CX5.90

CX6.80
CX6.90

CX7–8



STAGE 4B - STAGE V – MY18/19/20/21

CX7.80
CX7.90

CX8.70
CX8.80
CX8.90

CR



CR REVELATION – STAGE 4B – STAGE V – MY18/19/20/21

CR7.80
CR7.90

CR8.80
CR8.90

CR9.80
CR9.90

CR10.90

FR



FR FORAGE CRUISER

FR480
FR550

FR650
FR780

FR920

BIGBALER PLUS



Standard, Packer Cutter & Rotor Cutter – MY18/19/20/21

870
890

1270
1290

Accessories shown in this catalogue are only proposals for selected models. Please refer to nearest dealer for exact selection for your machine.



07

**HARVESTING
ACCESSORIES**





NEW HOLLAND CR – ROTARY COMBINE

Pictures shown here are for illustration purpose only.
Please see your local dealer for model applicability
and correct PN for your machine.

1

47869654

Proximity Mirror

A fixed wide angle Mirror that allows the driver to look at the immediate proximity of the right hand traction tyre. It is mounted on the same support as the normal mirrors.

CR



MY 2016-2021

2

51538882

Handheld Light in cabine

Mounted on the UCM cover on the right hand side of the seat.

CR



MY 2019-2021

3

47835803

Cabine Printer

Used to print all sub-menu information.

CR



MY 2017-2021

4

47706577

Cup Holder

Double cup holder, clicks onto the display sliding rail

CR



MY 2015-2021

5

47674481

Moisture Sensor

Fitted on the grain elevator to check the grain moisture.

CR



MY 2012-2021

6

51443288

Grain Flow Sensor

Can be installed together with the moisture sensor to measure mass flow.

CR



MY 2019-2021

7

47822761

Camera Kit

The camera can be mounted where ever required around the machine with the harness connecting to the right hand side console. Up to 3 cameras can be connected. The operator will be able to select between the camera inputs and the run screens. Each camera input will be displayed over the full screen.

CR



MY 2015-2021

8

47994967

Heated Floormat

To keep feet warm during cold harvest days, an optional heated floormat can be installed on the cab floor. The floormat can be plugged into the 12V socket on the left side of the operator seat and easily been turned on or off with a switch on the harness. The heated floormat provides electric heating power in a dedicated surface area around the operator's feet.

CR



MY 2019-2021

9

47810871

Hand Cleaning Station

The Hand Wash Station consists of a water tank with tap. The station is easily accessed from the left side of the machine, near the cab access ladder.

CR



MY 2018-2021

10

84149941

Grainpan Side Slope

When harvesting on slopes, Grain Pan Floating Dividers can be installed on the Grain Pan to avoid overloading the sides of the cleaning shoe. These Dividers can remain installed for all crops.

CR



MY 2010-2021

11

47904798

Unloading Auger Down to Spout

The Chute will add approximately 0.9m (3ft) to the effective unloading length when compared to the original "down" Spout. To ensure the Chute is vertical when in the fully forward position for unloading, it is positioned at an angle of 13.5° when in the transport cradle.

CR



MY 2018-2021



Pictures shown here are for illustration purpose only. Please see your local dealer for model applicability and correct PN for your machine.



NEW HOLLAND CX – CONVENTIONAL COMBINE

Pictures shown here are for illustration purpose only.
Please see your local dealer for model applicability
and correct PN for your machine.

1

47869654

Proximity Mirror

A fixed wide angle Mirror that allows the driver to look at the immediate proximity of the right hand traction tyre. It is mounted on the same support as the normal mirrors.

CX5-6



CX7-8



MY 2017-2021

2

47835803

Cabine Printer

Used to print all sub-menu information.

CX5-6



CX7-8



MY 2018-2021

3

47706577

Cup Holder

Double cup holder, clicks onto the display sliding rail

CX5-6



CX7-8



MY 2016-2021

4

47994967

Heated Floor mat

To keep feet warm during cold harvest days, an optional heated floor mat can be installed on the cab floor. The floor mat can be plugged into the 12V socket on the left side of the operator seat and easily been turned on or off with a switch on the harness. The heated floor mat provides electric heating power in a dedicated surface area around the operator's feet.

CX5-6



CX7-8



MY 2019-2021

5

48057254

Camera Kit

The camera can be mounted where ever required around the machine with the harness connecting to the right hand side console. Up to 3 cameras can be connected. The operator will be able to select between the camera inputs and the run screens. Each camera input will be displayed over the full screen.

CX5-6



CX7-8



MY 2017-2021

6

47876355

Moisture Sensor

Fitted on the grain elevator to check the grain moisture.

CX5-6



CX7-8



MY 2017-2021

7

51443288

Grain Flow Sensor

Can be installed together with the moisture sensor to measure mass flow.

CX5-6



CX7-8



MY 2019-2021



Pictures shown here are for illustration purpose only.
Please see your local dealer for model applicability
and correct PN for your machine.



NEW HOLLAND FORAGE HARVESTER

Pictures shown here are for illustration purpose only.
Please see your local dealer for model applicability
and correct PN for your machine.

1

51590584

Portable Work Light (LED)

Portable LED light with battery and magnetic support for cabine.

FR



MY 2021

2

48094866

Cabine Printer

Used to print all sub-menu information.

FR



MY 2018-2021

3

51631112

Crop Analysis Sensor

Crop analysis sensor, including spout door and wear plate for standard spout

FR



MY 2021

4

51473626

Pneumatic horn

The louder horn is to improve communication in the field. It does not replace the current horn, it is an additional option. Sound is 118dB at 2 meters distance. Dual trumpets of 180Hz and 150Hz.

FR



MY 2020-2021

5

47811093

Camera Kit

The camera can be mounted where ever required around the machine with the harness connecting to the right hand side console. Up to 3 cameras can be connected. The operator will be able to select between the camera inputs and the run screens. Each camera input will be displayed over the full screen.

FR



MY 2016-2020

6

48178252

Moisture Sensor

Located in the rear Spout cover. Includes the dummy plate to exchange with the Moisture Sensor when Moisture logging is not required. This is done to extend the lifetime of the Sensor when working in abrasive crop conditions.

FR



MY 2019-2021

7

47699882

Cool Box

The Cool Box can be placed under the instructor's seat. The Cool Box comes with power leads for 12/24 VDC and for 230VAC. The Cool Box is removable so the driver can take it with him.

FR



MY 2016-2021



8

439687001

IntelliFill™

The IntelliFill™ system allows the operator to fill a trailer accurately and with minimal losses, even when visibility is limited. Following a front-to-rear or rear-to-front pattern, the automatic trailer tracking system uses a specialised 3D NIR sensor mounted under the spout to guide the crop flow into the trailer. The system ensures a uniform fill whether the trailer is alongside the Forage Harvester, or following, in the case of starting new fields. The system can accurately control the crop flow trajectory even when operating at night.

FR



MY 2021

9

51439749

Yield sensor

The Yield Sensor indicates the crop mass flow during harvest. A Sensor in the feed roll area measures the amount of opening of the feed rolls, and derives the tonnage of crop passing through the Forage Harvester using the signal from the Moisture sensor or based on the manual Moisture % input in the display.

FR



MY 2019-2021



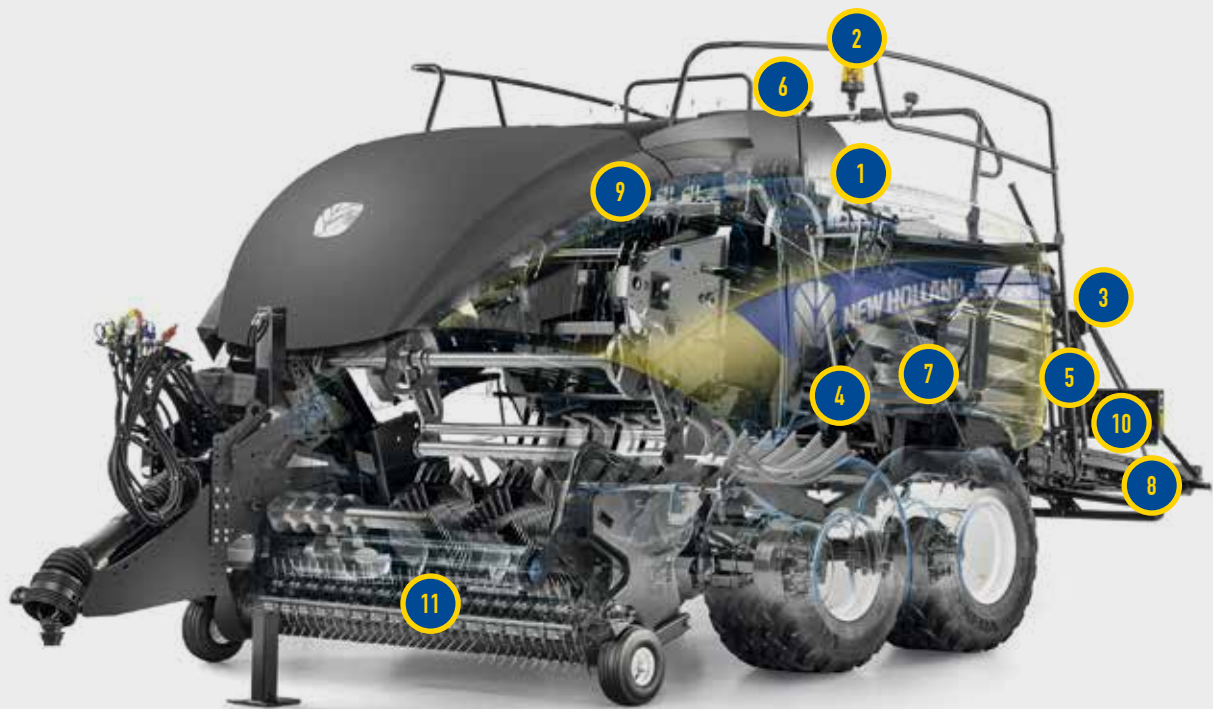





Pictures shown here are for illustration purpose only. Please see your local dealer for model applicability and correct PN for your machine.

















NEW HOLLAND LARGE SQUARE BALER





| | | | |
|------------------------------------------------------------------------------------------------------------------------------------------------------------------------------------------------------|------------------------------------------------------------------------------------------------------------------------------------------------------------------------------------------------------|-------------------------------------------------------------------------------------------------------------------------------------------------------------------------------------------------------------------------|------------------------------------------------------------------------------------------------------------------------------------------------------------------------------------------------------------------------------|
| 1 48097356 | 2 48187100 | 3 48099941 | 3 47964855 |
| Toolbox on Top Service Deck | LED Beacon | Partial Bale Eject | Partial Bale Eject |
| Toolbox positioned on the top service deck, close to the knotter area | For optimal visibility | Fitted in addition to Standard Bale Eject. Two tines on each rail will eject a bale sticking out of the bale chamber without touching the (untied) bale in process. | Fitted in addition to Standard Bale Eject. Two tines on each rail will eject a bale sticking out of the bale chamber without touching the (untied) bale in process. |
| BB  BB PLUS  MY 2018-2021 | BB  BB PLUS  MY 2018-2021 | BB  BB PLUS  BB Plus 870-890 / MY 2018-2021 | BB  BB PLUS  BB Plus 1270-1290 / MY 2018-2021 |

Pictures shown here are for illustration purpose only. Please see your local dealer for model applicability and correct PN for your machine.

| | | | |
|------------------------------------------------------------------------------------------------------------------------------------------------------------------------------------------------------------------------------------------------------------------------------------------------------------------------------------------------------------------------------------------------|----------------------------------------------------------------------------------------------------------------------------------------------------------------------------------------------------------------------------------------------------------------------------------------------------------------------------------------------------------------------------------------------------------------|-----------------------------------------------------------------------------------------------------------------------------------------------------------------------------------------------------------------------------------------------------------------------------------------------------------------------------------------------------------------------------------------------|------------------------------------------------------------------------------------------------------------------------------------------------------------------------------------------------------------------------------------------------------------------------------------------------------------------------------------------------------------------------------------------------------------------------|
| <p>4 84101701</p> <p>Quick Fill Pump</p> <p>Using the Grease reservoir Fill Pump prevents dust and dirt contamination inside the Greasing circuit during refill.</p> <p>BB  BB PLUS </p> <p>MY 2013-2021</p> | <p>5 84600138</p> <p>Mechanical Bale Counter</p> <p>In addition to the Bale Counter functions provided on your monitor, a mechanical bale counter can be installed on the Baler.</p> <p>BB  BB PLUS </p> <p>MY 2013-2021</p> | <p>6 48149845</p> <p>Camera + Additional Monitor</p> <p>Camera and additional high resolution monitor. Camera used to optimize view at the rear of the baler.</p> <p>BB  BB PLUS </p> <p>MY 2019-2021</p> | <p>7 51428551</p> <p>Moisture Sensor (Rub Pad)</p> <p>Dual rubpad type moisture sensor, displays on the go moisture content workscreen. Moisture capture in logging isoXML (option).</p> <p>BB  BB PLUS </p> <p>MY 2020-2021</p> |
|------------------------------------------------------------------------------------------------------------------------------------------------------------------------------------------------------------------------------------------------------------------------------------------------------------------------------------------------------------------------------------------------|----------------------------------------------------------------------------------------------------------------------------------------------------------------------------------------------------------------------------------------------------------------------------------------------------------------------------------------------------------------------------------------------------------------|-----------------------------------------------------------------------------------------------------------------------------------------------------------------------------------------------------------------------------------------------------------------------------------------------------------------------------------------------------------------------------------------------|------------------------------------------------------------------------------------------------------------------------------------------------------------------------------------------------------------------------------------------------------------------------------------------------------------------------------------------------------------------------------------------------------------------------|

| | | | |
|-------------------------------------------------------------------------------------------------------------------------------------------------------------------------------------------------------------------------------------------------------------------------------------------------------------------------------------------------------------------------------------------------------------------------------|---------------------------------------------------------------------------------------------------------------------------------------------------------------------------------------------------------------------------------------------------------------------------------------------------------------------------------------------------------------------------------------------------------------------------------|----------------------------------------------------------------------------------------------------------------------------------------------------------------------------------------------------------------------------------------------------------------------------------------------------------------------------------------------------------------------------------------------------------------------------------------------|--------------------------------------------------------------------------------------------------------------------------------------------------------------------------------------------------------------------------------------------------------------------------------------------------------------------------------------------------------------------------------------------------------------------------------------------------|
| <p>8 48094181</p> <p>Roller Bale Chute</p> <p>For smooth Bale drop and in cab Bale drop indication. The Chute is lifted and lowered hydraulically from the back of the Baler.</p> <p>BB  BB PLUS </p> <p>BB Plus 870-890 / MY 2018-2021</p> | <p>8 48024685</p> <p>Roller Bale Chute</p> <p>For smooth Bale drop and in cab Bale drop indication. The Chute is lifted and lowered hydraulically from the back of the Baler.</p> <p>BB  BB PLUS </p> <p>BB Plus 1270-1290 / MY 2018-2021</p> | <p>9 47602288</p> <p>Pneumatic Knotter Blow-off (With Compressor)</p> <p>Pneumatic knotter blow off including compressor, to be used in combination with tractors without pneumatic brakes</p> <p>BB  BB PLUS </p> <p>BB Plus 870-890 / MY 2015-2021</p> | <p>9 47602289</p> <p>Pneumatic Knotter Blow-off (With Compressor)</p> <p>Pneumatic knotter blow off including compressor, to be used in combination with tractors without pneumatic brakes</p> <p>BB  BB PLUS </p> <p>BB Plus 1270-1290 / MY 2015-2021</p> |
|-------------------------------------------------------------------------------------------------------------------------------------------------------------------------------------------------------------------------------------------------------------------------------------------------------------------------------------------------------------------------------------------------------------------------------|---------------------------------------------------------------------------------------------------------------------------------------------------------------------------------------------------------------------------------------------------------------------------------------------------------------------------------------------------------------------------------------------------------------------------------|----------------------------------------------------------------------------------------------------------------------------------------------------------------------------------------------------------------------------------------------------------------------------------------------------------------------------------------------------------------------------------------------------------------------------------------------|--------------------------------------------------------------------------------------------------------------------------------------------------------------------------------------------------------------------------------------------------------------------------------------------------------------------------------------------------------------------------------------------------------------------------------------------------|

| | | |
|------------------------------------------------------------------------------------------------------------------------------------------------------------------------------------------------------------------------------------------------------------------------------------------------------------------------------------------------------------------------------------------------------------------------------------------------------------------------------------------------------------------------------------------------------------------------------------------------------------------------------------------------------------------------------------------|----------------------------------------------------------------------------------------------------------------------------------------------------------------------------------------------------------------------------------------------------------------------------------------------------------------------------------------------------------------------------------------------------------------------------------------------------------------------------------------------------------------------------------------------------------------------------------------------------------------------------------------------------------------------------------------------------------------------------------------------------------------------------|--------------------------------------------------------------------------------------------------------------------------------------------------------------------------------------------------------------------------------------------------------------------------------------------------------------------------------------------------------------------------------------------------------------------------------------------------------------------------------------------------------------------------------------------------------------------------------------------------------------------------------------------------------------------------------------------------------------------------------------------|
| <p>9 47361569</p> <p>Pneumatic Knotter Blow-off</p> <p>Pneumatic Knotter Blow-off This extra Knotter Blow Off Kit is making use of compressed air and can be used in combination with the existing standard electrical fan cleaning system for heavy duty cleaning performance. This Kit can only be used in combination with a Tractor equipped with Pneumatic Braking System. Can be adjusted to blow from under the Knotters or above the Knotters.</p> <p>BB  BB PLUS </p> <p>MY 2013-2021</p> | <p>10 48043464</p> <p>ActiveWeigh™ - Bale Weighing System</p> <p>ActiveWeigh™ - Bale Weighing System Highly accurate (+/- 2%) weighing on-the-go, without slowing down or stopping the baling process.</p> <ul style="list-style-type: none"> - Isolation of the bale from next bale and non-weighing part of bale chute. - Can handle different bale dimensions. - Can cope with different crops and crop conditions. - Functions independently of slopes or machine movements. <p>BB  BB PLUS </p> <p>BB Plus 870-890 / MY 2019-2021</p> | <p>10 47976967</p> <p>ActiveWeigh™ - Bale Weighing System</p> <p>Highly accurate (+/- 2%) weighing on-the-go, without slowing down or stopping the baling process.</p> <ul style="list-style-type: none"> - Isolation of the bale from next bale and non-weighing part of bale chute. - Can handle different bale dimensions. - Can cope with different crops and crop conditions. - Functions independently of slopes or machine movements. <p>BB  BB PLUS </p> <p>BB Plus 1270-1290 / MY 2019-2021</p> |
|------------------------------------------------------------------------------------------------------------------------------------------------------------------------------------------------------------------------------------------------------------------------------------------------------------------------------------------------------------------------------------------------------------------------------------------------------------------------------------------------------------------------------------------------------------------------------------------------------------------------------------------------------------------------------------------|----------------------------------------------------------------------------------------------------------------------------------------------------------------------------------------------------------------------------------------------------------------------------------------------------------------------------------------------------------------------------------------------------------------------------------------------------------------------------------------------------------------------------------------------------------------------------------------------------------------------------------------------------------------------------------------------------------------------------------------------------------------------------|--------------------------------------------------------------------------------------------------------------------------------------------------------------------------------------------------------------------------------------------------------------------------------------------------------------------------------------------------------------------------------------------------------------------------------------------------------------------------------------------------------------------------------------------------------------------------------------------------------------------------------------------------------------------------------------------------------------------------------------------|

| | |
|-----------------------------------------------------------------------------------------------------------------------------------------------------------------------------------------------------------------------------------------------------------------------------------------------------------------------------------------------------------------------------------------------------|------------------------------------------------------------------------------------------------------------------------------------------------------------------------------------------------------------------------------------------------------------------------------------------------------------------------------------------------------------------------------------------|
| <p>11 51430492</p> <p>Polyurethane Pick-up Guards Rotor</p> <p>Set of 5 polyurethane pick-up guards in New Holland Yellow</p> <p>BB  BB PLUS </p> <p>All Standard & Packer Cutter BigBalers / MY 2021</p> | <p>11 51430489</p> <p>Polyurethane Pick-up Guards Rotor</p> <p>Set of 5 polyurethane pick-up guards in New Holland Yellow</p> <p>BB  BB PLUS </p> <p>Only for Rotor Cutter BigBalers / MY 2021</p> |
|-----------------------------------------------------------------------------------------------------------------------------------------------------------------------------------------------------------------------------------------------------------------------------------------------------------------------------------------------------------------------------------------------------|------------------------------------------------------------------------------------------------------------------------------------------------------------------------------------------------------------------------------------------------------------------------------------------------------------------------------------------------------------------------------------------|



Pictures shown here are for illustration purpose only. Please see your local dealer for model applicability and correct PN for your machine.

The Fluids and Lubricants Recommended by NEW HOLLAND



AKCELA®

AMBRA range of products is the result of a co-engineering between PETRONAS Lubricants International and NEW HOLLAND in order to maximize the performance and reliability of machineries thus optimizing the TCO (Total Cost of Ownership).

